

# PARQUE URBANO CARCAVELOS - SUL

## ANTE PROJECTO

OUTUBRO 2013

Divisão de Planeamento e Ordenamento do Território

## 7.2 anexo de equipamentos recreativos

04215



# PARQUE URBANO QUINTA DOS INGLESINHOS



View B ▲



View A ►

0421



Playmakers® Design  
500-0613.DIR

Age Group: 5 to 12

Capacity: 188 Children

Play Events: 84 Fun-Filled Events

Structure Size: 59'6" x 65'11" x 14"  
(L x W x H)  
18,14m x 20,06m x 4,27m

Use Zone: 67'7" x 79"  
20,6m x 24,06m

Colors:



## PLAYWORLD™

©2007 Playworld Systems, Inc.  
Playworld™ is a brand of Playworld Systems®, Inc.

Playground Supervision Required

CÂMARA MUNICIPAL  
**RECEBIMOS**  
 28 ABR 2014  
 CASCAIS

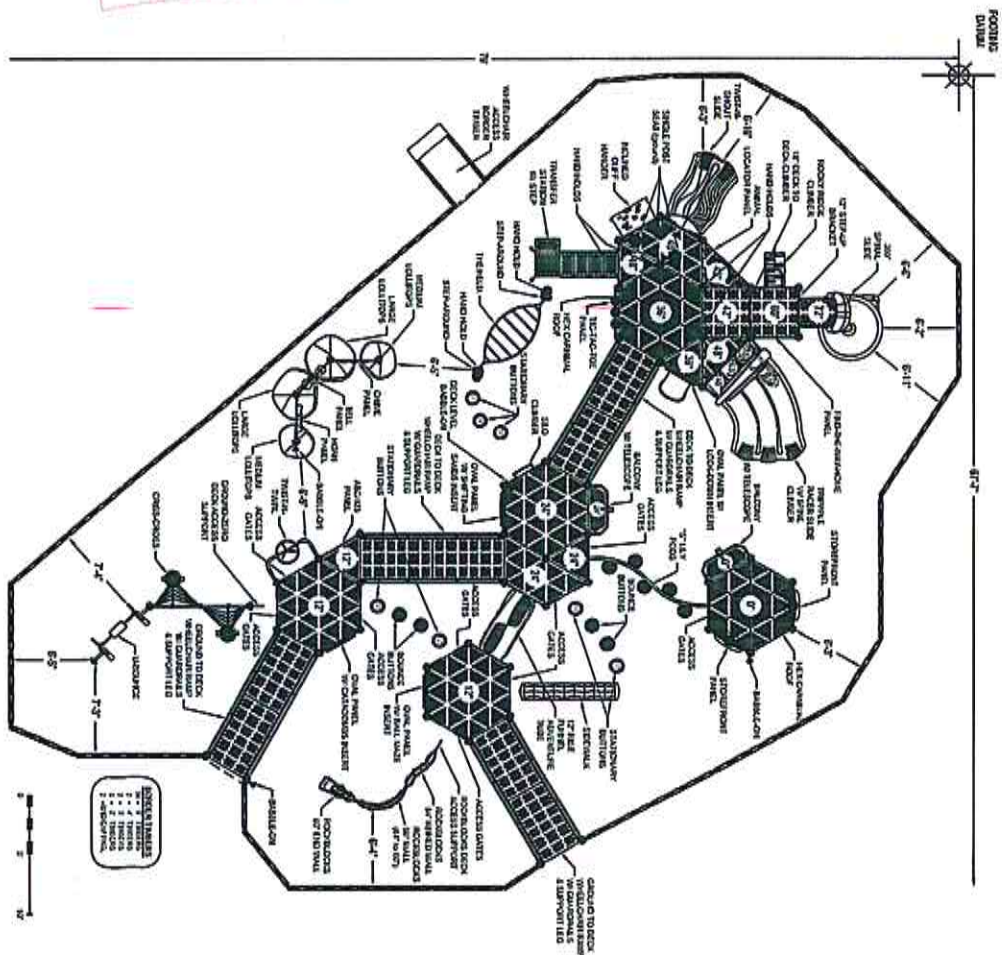

**PLAYWORLD™**

© 2007 Playworld Systems, Inc.  
 Playworld™ is a brand of Playworld Systems, Inc.

PROJECT NO: 500-0813	REV: -	DATE: 12-DEC-07
SYSTEM: PLAYMAKERS		SCALE: 3/32" = 1'-0"
SITE PLAN		DRAWN BY: CHIP ZECHMAN

Playworld Systems, Inc.  
 1000 Buffalo Road  
 Lewisburg, PA  
 17837-9795 USA

**PARQUE URBANO QUINTA DOS INGLES!**

CARCAVELOS



# Boundless Playgrounds Certified Model (Equipment Only) Certificate

This Certificate authorizes Playworld Systems to utilize the Boundless Playgrounds Certification Logo on the configuration identified below by the Drawing Number and Configuration Library Number. The use of the Boundless Playgrounds Certification Logo signifies that Playworld Systems has received written validation from Boundless Playgrounds that the model specified complies with the Boundless Playground Performance Criteria for Play Equipment.

Any changes made to the Boundless Playgrounds Certified Model specified below have to be reviewed and re-certified by Boundless Playgrounds. For information regarding the entire play environment being assessed and identified as a Boundless Playground please go to [www.boundlessplaygrounds.org](http://www.boundlessplaygrounds.org) and check out the Go Play! program.

Partner's Drawing Number: 500-0813  
Configuration Library Number: P0610 - G0027



National Center for Boundless Playgrounds  
45 Wintonbury Ave., Bloomfield, CT 06002  
860-243-8315  
[www.boundlessplaygrounds.org](http://www.boundlessplaygrounds.org)

Certified by: **Monique Farias**  
Certified on: **September 6, 2007**

*This authorization is valid for the calendar year in which it is certified.*

04217



CĂMARA MUNICIPAL  
REPUBLICA MOLDOVA  
28 APR. 2014  
CORCHIAȘI

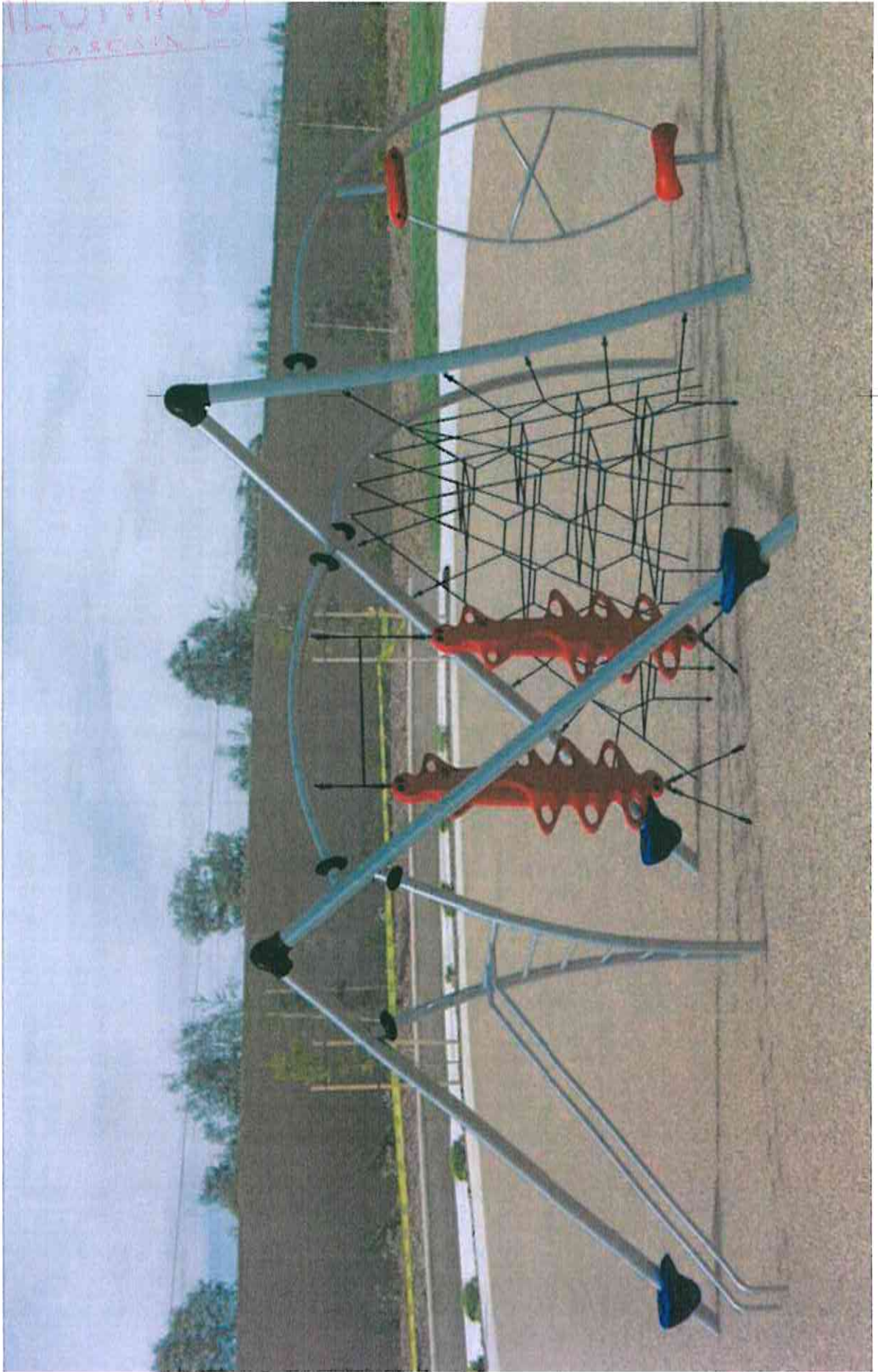



04218

CĂMARA MUNICIPAL  
REF. PS. AL. 10  
2.0 APR. 2014

# FUNKY ANIMALS WITH SOUND



- Bring a whole new world of pretend play to the youngest children in your park.
- Available in your choice of four designs: horse, cow, bumble bee and ladybug.
- Each animal makes the appropriate sound and plays music when a child interacts and plays on it. For example, the cow will "moo".
- Overall height, handholds and footholds are lower to specifically accommodate young children, age 2-5 years old. Even the animal's head is lower, so it's a more ergonomic fit.
- Funky Animals were designed for one toddler at a time. And the c-spring coil springs her forward for a thrilling but safe ride.
- Available with and without sound.
- Colors are as shown.



Horse



Bumble Bee



Cow



Ladybug

NRPA Booth #3837



**PLAYWORLD  
SYSTEMS®**

The world needs play.™









Technical Information



**PLAYWEB LARGE**

ZZXX0020



-  3-14
-  30
-  10122 x 10882
-  86,65 m<sup>2</sup>
-  3,0 m
-  28 Hrs
-  557,7 kg
- 

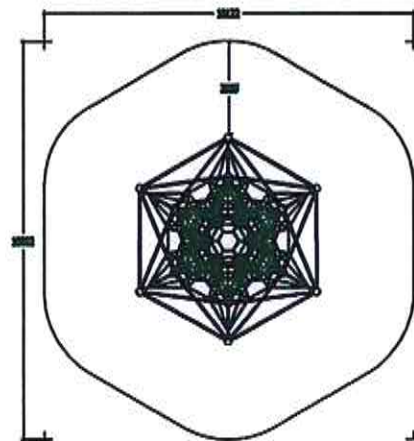
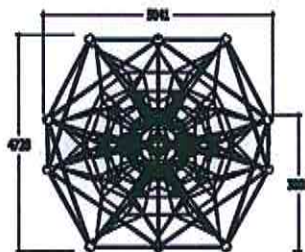
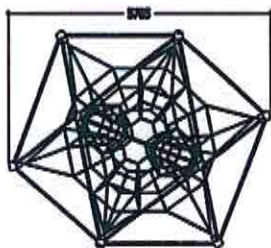

[www.playworldsystems.com](http://www.playworldsystems.com)



# The Making of a Playworld Systems Playstructure

Quality you can see, value you can measure!

## Perforated Steel Decks and Stairs

- Made of single-piece perforated steel, flange-formed around the edges for safety.
- Reinforced with extra support beams for maximum strength and minimum flex.
- Sealed with 80-100 mils of PlayArmour™ coating, making them virtually impervious to rust and corrosion.
- Salt bath cure for better quality characteristics in the vinyl and permits even cooling.



## ISO 9001 Quality Certification

- Exacting quality control standard that applies to every facet of business.
- Internationally recognized quality standard.

## Compounded Rotomolded Plastic

- Color-impregnated solid color polyethylene resin for greater bonded strength.
- Superior colorfastness and U.V. resistance.
- Up to 23 times greater impact resistance over dry-blended plastic resin.



10 Year Warranty

## Coped Weldments

- Coped weldments are designed to meet tough urban specifications.
- Produces a stronger weld because more of the tubing surface is in direct contact at the weldment.
- Robotic welding improves the weld quality and aesthetic look of the weld joint.



## Triple-Coated Posts and Tubing

- Interior corrosion resistant with zinc-rich coating.
- Hot-dipped Flo-Coat™ zinc galvanizing.
- Chromate conversion coating topped with a clear polymer coating.
- Baked-on polyester powder coating creates good-looking and incredibly tough outer finish.
- Available in galvanized steel or recycled aluminum.



15 Year Warranty

## Stainless Steel Hardware

- All stainless steel hardware will never rust or corrode.
- Premium grade for maximum durability.
- Exclusive tamper-resistant bolts on all clamps and exposed connections.
- Locking nuts inhibit loosening during use.



10 Year Warranty

## Powder Coated Finish

- Electrostatically applied polyester powder, baked and cured to a hard, smooth surface.
- Highly decorative finish resistant to abrasions, corrosion, and weather.
- Finish conforms to ASTM specifications such as: salt spray test, weatherability, and impact resistance test.



## Double-Banded Clamp

- Die-cast aluminum alloy for higher quality consistency and strength.
- Hinged design with simple one-bolt fastening system that eliminates nuts and simplifies installation.
- Vandal-resistant stainless steel hardware and drive rivet provide extra security.
- Unique S-clip design eliminates sliding entanglement points at conflation.

Lifetime WARRANTY



04219

AMARA MUNICIPAL  
20 APR. 2014  
CASCAIS  
**PLAYWORLD SYSTEMS®**  
www.playworldsystems.com

aled



# Lifetrail™

PLAYWORLD SYSTEMS®



CĂMARA MUNICIPALĂ  
DE  
28 APR. 2014

[www.playworldsystems.com/lifetrail](http://www.playworldsystems.com/lifetrail)





# FUNDAMENTOS DO LIFETRAIL

Cada Estação tem a forma de um triângulo (3 faces)

- Duas faces reservadas para Actividade Física específica
- Uma face disponível para Painel Informativo ou Patrocínios





# PAINÉIS INFORMATIVOS STANDARD

- Benefícios do exercício
- Osteoporose
- Tai Chi
- Alimentação Saudável
- Postura
- Redução do Stress /  
Controlo da dor
- Yoga
- Exercício para a mente
- Osteoartrite
- Prevenção de Quedas





# ACTIVIDADES DISPONÍVEIS PARA UTILIZADORES EM CADEIRA DE RODAS



- Rotação dos antebraços
- Aquecimento dos membros superiores
- Alongamentos
- Elevações
- Alongamento e fortalecimento dos membros superiores

04221

CÂMARA MUNICIPAL  
DE  
2018  
10



# AS ESTAÇÕES LIFETRAIL

## Estação Nº 1 Estação de Boas Vindas

- Introdução ao "LifeTrail"
- Descrição dos benefícios
- Indicações para a utilização correcta e segura



## Estação N° 2 Aquecimento dos membros inferiores

- Semelhante a uma Bicicleta estática.
- Adaptável a utilizadores com alturas diferenciadas.
- Resistência ajustável ao nível do utilizador



04222





## Estação n° 3 Banco de "Step"

- Aumenta a resistência e força dos membros inferiores
- Dois níveis de degrau
- Barras de Apoio e tapetes anti-derrapantes para garantir a segurança
- Melhora o equilíbrio

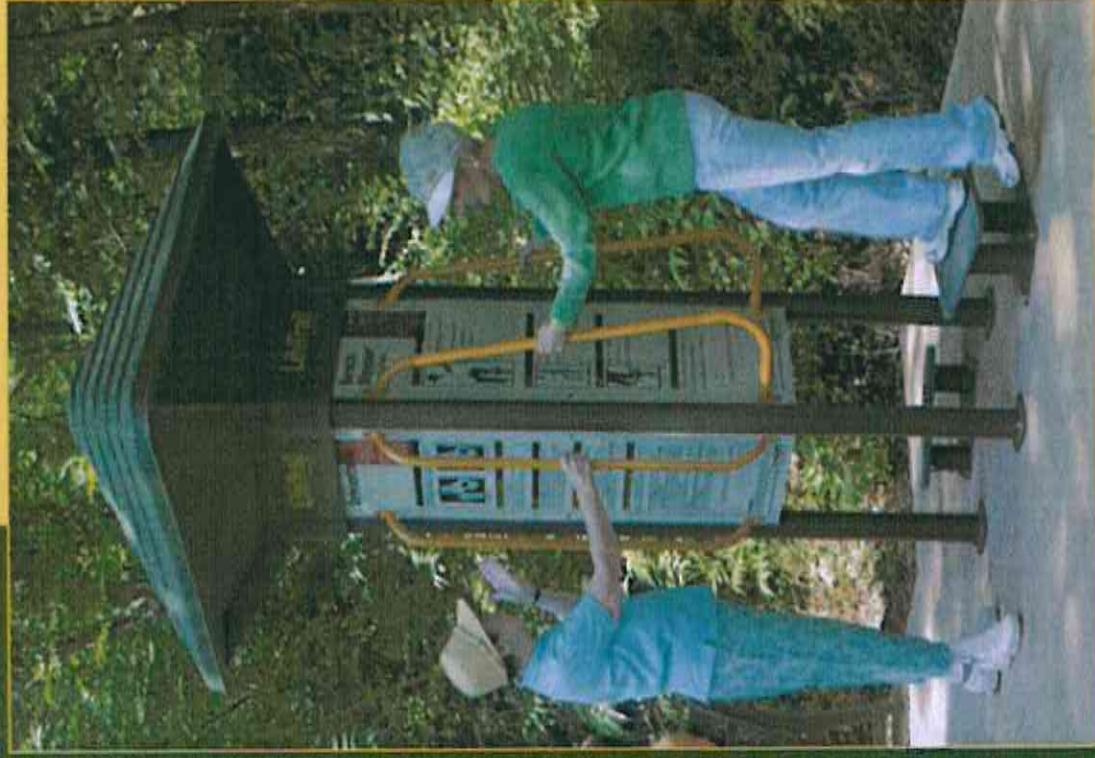



## Estação nº 4 Fortalecimento do Tronco e Músculos Abdominais



- Melhora a postura e Fortalece os Músculos da Coluna Vertebral
- Exercício "sentado" para fortalecimento abdominal

04223





## Estação Nº 5 Aquecimento dos Membros Superiores



- Rotação dos braços com resistência variável
- Aumenta a temperatura do corpo e prepara o coração e pulmões para a Actividade Física que vai iniciar
- Aumenta a força e resistência dos membros superiores



## Estação Nº 6 Flexões

- Fortalece os músculos do braços, e do peito



04224





## Estação N° 7 Rotação dos Antebraços

- Fortalece os antebraços e os músculos das mãos

- A resistência é ajustável ao nível do utilizador





## Estação Nº 8 Alongamento e Fortalecimento dos Membros Superiores

- Promove o relaxamento da zona superior das costas e dos músculos do pescoço
- Fortalece os músculos dos braços e do peito
- Dois níveis de esforço proporcionam dois níveis de treino



04225

CÂMARA MUNICIPAL  
PÚBLICA  
28 JUN 2011





## Estação nº 9

### Alongamento dos Membros Inferiores

- O alongamento em pé aumenta a flexibilidade dos músculos posteriores da coxa e dos gêmeos
- Dois níveis de alongamento disponíveis



CÂMARA MUNICIPAL  
RECEBUEMOS  
28 ABR 2015  
SANTARÉM



## Estação N°10 Equilíbrio

- Desenvolve força nas pernas
- Melhora o equilíbrio e a postura

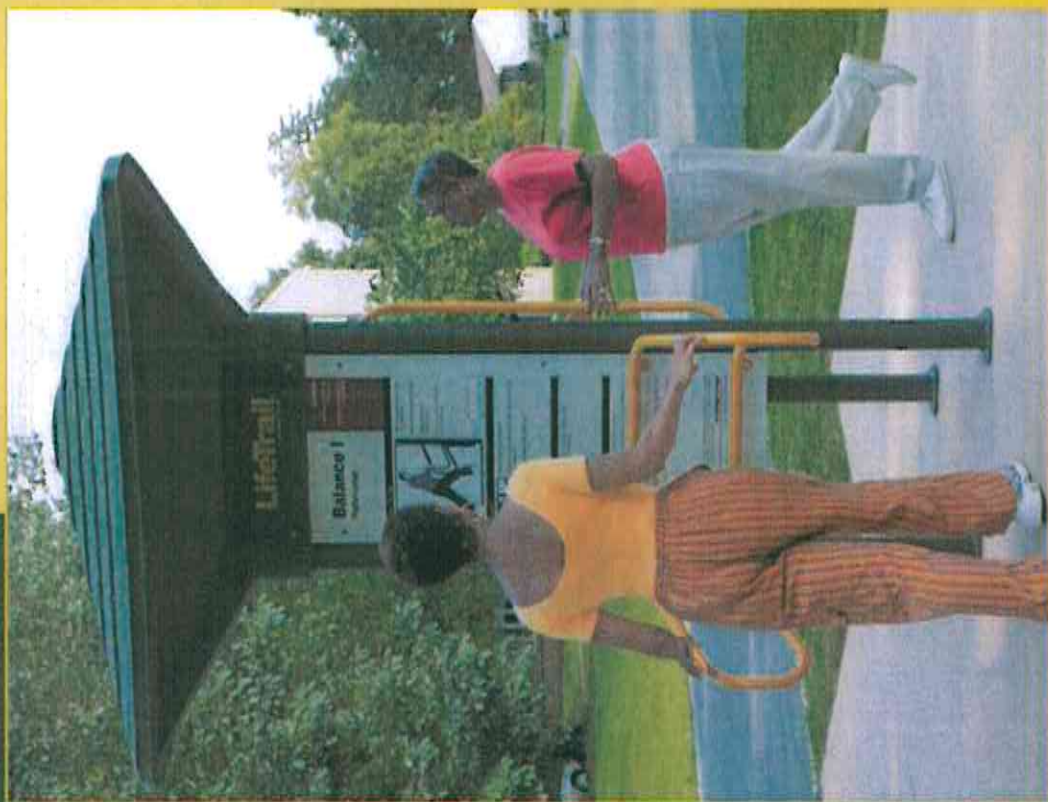

04226





CAMARA MUNICIPAL  
RECIBIDO  
28 ABR 2004  
CASCAIS

2007  
LIFETRAIL



- NOTES:**
- 1) This station detail is a diagram of the placement of activity panels on LifeTrail™ Stations.
  - 2) The station number filled in the title block is labeled on the Site Plan to reference the station's location on the overall site.
  - 3) It is recommended that LifeTrail™ stations be installed on a concrete pad measuring 11' x 11' which is poured at least 4" thick.
  - 4) It is recommended that this and all LifeTrail™ stations be installed so that the activity on Side 2 is facing the point of access/egress to allow for adequate traffic flow and wheelchair accessibility (if applicable) around the station.
  - 5) This LifeTrail™ station consists of 1 motorized roof assembly, 3 powder-coated aluminum steel supports with all required hardware and the three activity panels shown on this detail, including all equipment and required hardware.
  - 6) This design configuration is the property of this firm and Playworld Systems and may not be reproduced or used in any manner without the expressed written consent of this firm and Playworld Systems.

PROJECT NO.	REV.	DATE
LT002S.DIR	A	04-JAN-07
STATION NUMBER	STATION 2	SCALE
		AS SHOWN
STATION DETAIL		DRAWN BY
		BRETT HARVEY

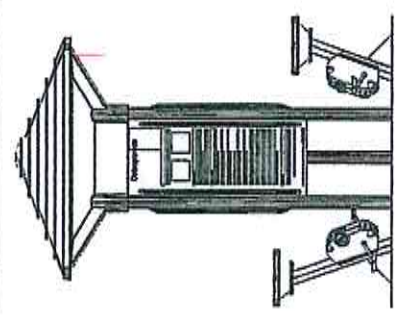

SIDE 3  
ACTIVITY: OBSTACLE COURSE  
PART NO.: ZALTR03  
SCALE: 1/8" = 1'-0"

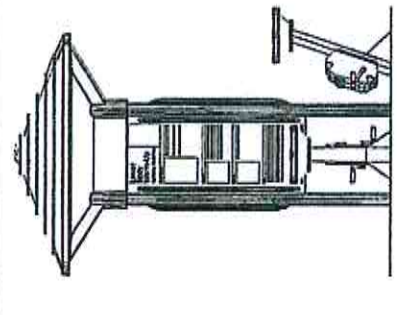

SIDE 2  
ACTIVITY: LOWER BODY WARM-UP - BALLS  
PART NO.: ZALTR02  
SCALE: 1/8" = 1'-0"

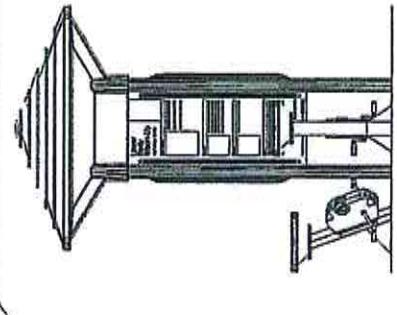

SIDE 1  
ACTIVITY: LOWER BODY WARM-UP - STRETCH  
PART NO.: ZALTR01  
SCALE: 1/8" = 1'-0"

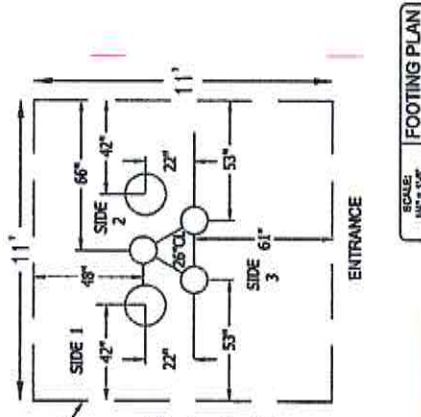

FOOTING PLAN  
SCALE: 1/8" = 1'-0"

NOTE: THIS IS A SURFACE MOUNT INSTALLATION. THE FOOTING PLAN IS ONLY PRESENT TO PROVIDE YOU WITH THE NECESSARY INFORMATION TO CENTER THE LIFETRAIL STATION ONTO THE CONCRETE PAD. IT IS NOT DIRECTIONS FOR DIGGING HOLES.

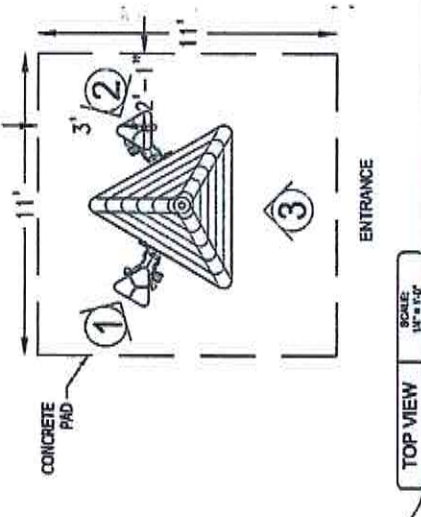

TOP VIEW  
SCALE: 1/8" = 1'-0"

Type in Project Name  
Type in City and State

**LifeTrail.**  
The Pathway to Total Wellness™  
© 2007 Playworld Systems, Inc.  
10000 S. 10th Street, Suite 100, Phoenix, AZ 85042

Street Address  
City, State Zip



Technical Information

# WORLDTRAIL LEG LIFT w/ SIGN

ZZWT00140



- 12 & >
- 2
- 4257 x 4437
- 15,61 m<sup>2</sup>
- 2,03m
- 2 Hrs
- 43,5 kg
- 

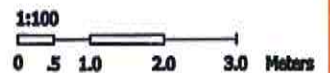
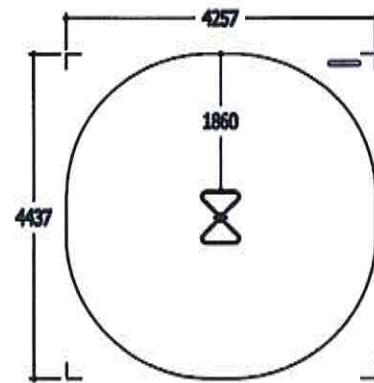
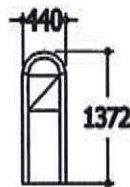
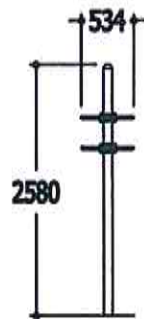
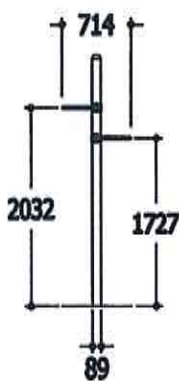

[www.playworldsystems.com](http://www.playworldsystems.com)











Technical Information

**WORLDTRAIL BODY CURL w/ SIGN**



ZZWT00150



-  12 & >
-  1
-  3823 x 5285
-  18,2 m<sup>2</sup>
-  0,35m
-  3 Hrs
-  72,1 kg
- 

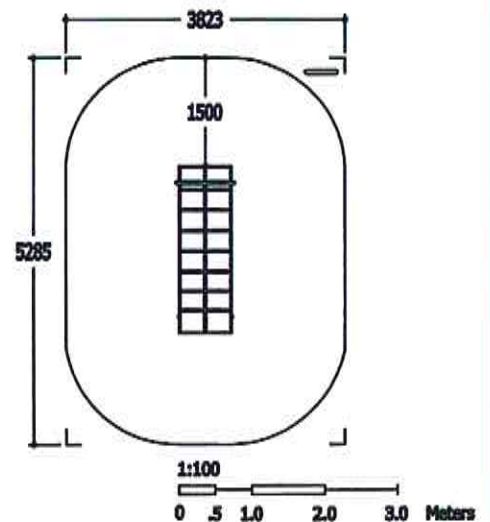

[www.playworldsystems.com](http://www.playworldsystems.com)



Technical Information

# WORLDTRAIL PARALLEL BARS w/ SIGN

ZZWT00160

MAMARA MUNICIPAL  
 REGRATO  
 28 ABR. 2014  
 CASCAIS



-  12 &gt; 04228
-  2
-  6567 x 3568
-  21,5 m<sup>2</sup>
-  0,84m
-  3 Hrs
-  67,2 kg
- 

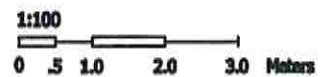
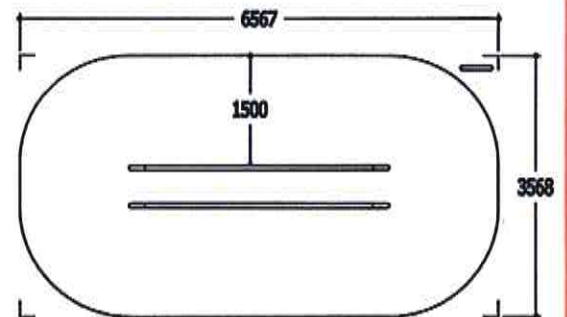
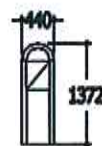
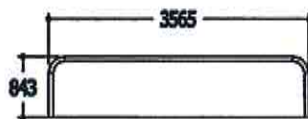
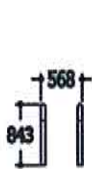

[www.playworldsystems.com](http://www.playworldsystems.com)









Technical Information

# WORLDTRAIL BEAM JUMP w/ SIGN



ZZWT00170



-  12 & >
-  2 —
-  5936 x 4620
-  20,2 m<sup>2</sup>
-  0,32m
-  4 Hrs
-  53,2 kg
- 

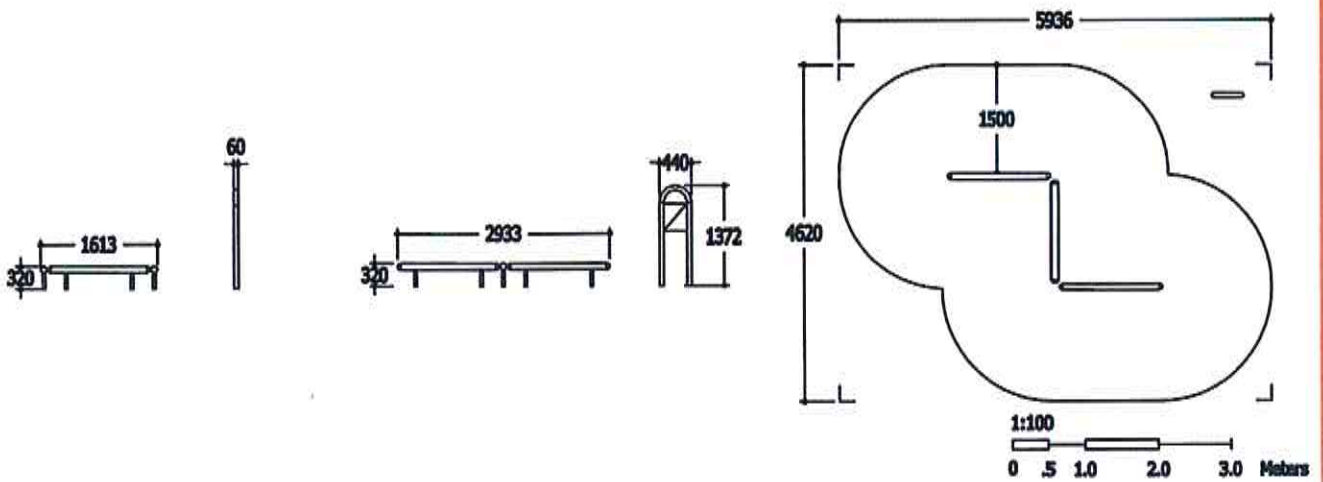

[www.playworldsystems.com](http://www.playworldsystems.com)



Technical Information









**WORLDTRAIL HORIZONTAL LOOP LADDER w/ SIGN**

CÂMARA MUNICIPAL  
**RECEBIMOS**  
 26 ABR. 2014  
 CASCAIS

ZZWT00190

04229



-  12 & >
-  2
-  6393 x 4280
-  25,1 m<sup>2</sup>
-  2,1 m
-  4 Hrs
-  142,4 kg
- 

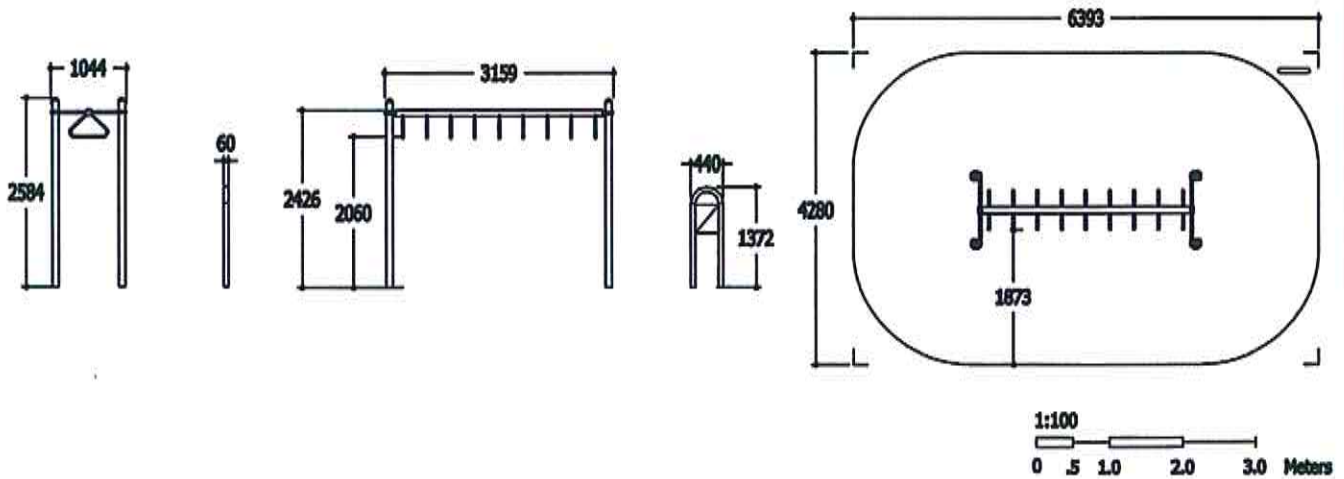

[www.playworldsystems.com](http://www.playworldsystems.com)









Technical Information

# WORLDTRAIL HIP ROTATION w/ SIGN

RECEIVED  
28 ABR. 2016  
REGRATIAO  
CASCAIS

ZZWT00210



-  12 & >
-  2
-  6511 x 4207
-  23,7 m<sup>2</sup>
-  2,34 m
-  2,5 Hrs
-  55,7 kg
- 

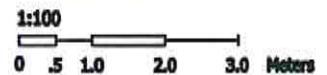
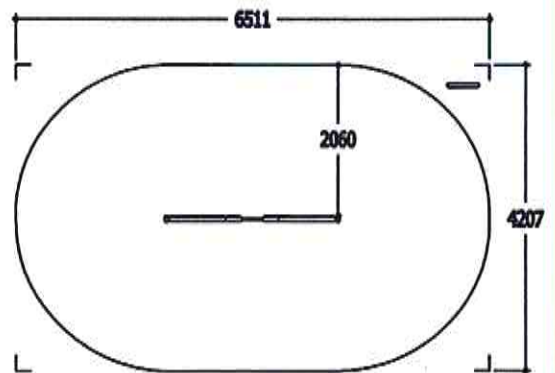
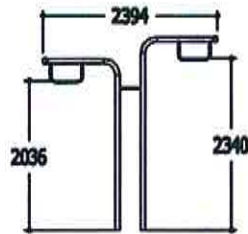

[www.playworldsystems.com](http://www.playworldsystems.com)











Technical Information

# WORLDTRAIL PUSH-UP w/ SIGN

ZZWT00220



-  12 & >
-  2
-  5130 x 3043
-  13,7 m<sup>2</sup>
-  0,31 m
-  3 Hrs
-  31,3 kg
- 

04230

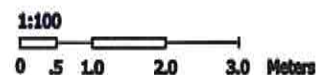
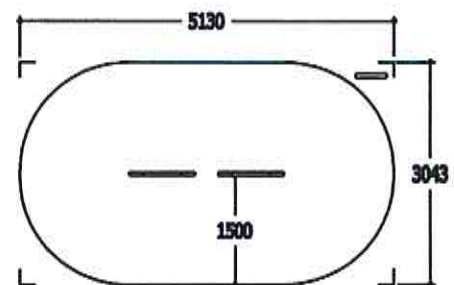

[www.playworldsystems.com](http://www.playworldsystems.com)









Technical Information

**WORLDTRAIL CHIN-UP w/ SIGN**



ZZWT00240



-  12 & >
-  2
-  5579 x 3874
-  18,5 m<sup>2</sup>
-  2,14 m
-  3 Hrs
-  81,4 kg
- 

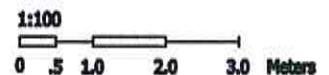
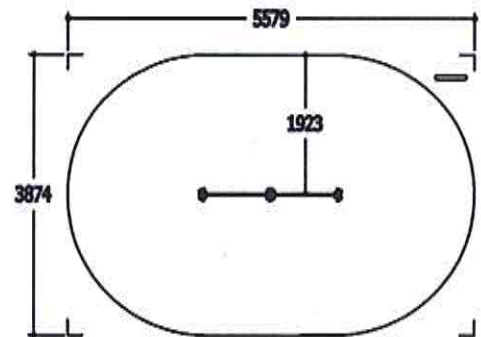
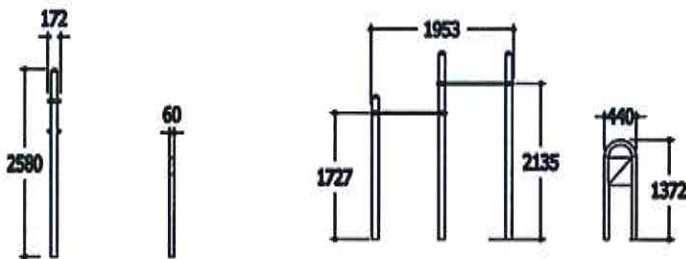

[www.playworldsystems.com](http://www.playworldsystems.com)



Technical Information

**WORLDTRAIL DURA BALANCE BEAM w/ SIGN**

ZZWT00360



-  12 & >
-  2 " 04231
-  6056 x 3101
-  16,9 m<sup>2</sup>
-  0,31 m
-  2 Hrs
-  47 kg
- 

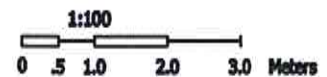
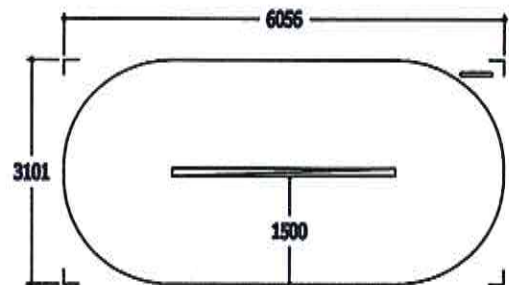
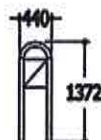
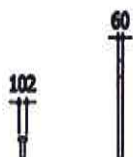

[www.playworldsystems.com](http://www.playworldsystems.com)